

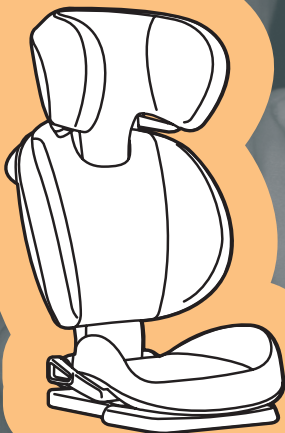

iZi Up

FORWARD-FACING

USER MANUAL



ECE R44 04

GROUP
2-3

WEIGHT
15-36 kg

AGE
4-12 y

BeSafe[®]

Thank you for choosing BeSafe iZi Up

BeSafe have developed this seat with great care to protect your child during the next phase of her or his life.

! It is important that you read this user manual BEFORE installing your seat. Incorrect installation could endanger your child.

Contents

Vital information	3
Preparing to install	4
Forward-facing belt installation	5
Removing the seat	7
Positioning the child	8
Sleeping position	9
Removing and refitting the cover	10
Cleaning instructions	10
Warning: potential misuse	11
Point of sale information	11
Important advice	12
Guarantee	13

Vital information

- It is **NOT ALLOWED** to mount the seat in a front passenger seat **WITH AN ACTIVATED AIRBAG**.
- iZi Up can be installed forward-facing with a 3-point belt, approved to UN/ECE Regulation No.16 or other.

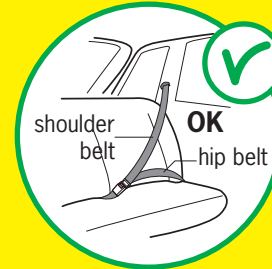

- iZi Up is approved in group 2-3, forward-facing from 15-36 kg.
- The child should **ALWAYS** be secured with the 3-point belt when seated in the child seat.
- After an accident, the seat must be replaced. Although it may look undamaged, if you were to have another accident, the seat may not be able to protect your child as well as it should.
- Prevent the iZi Up from becoming trapped or weighed down by luggage, seats and/or slamming doors.
- Before every use, make sure that the 3-point belt is not damaged or twisted and installed tight.
- If in doubt, consult either your retailer or the child restraint manufacturer.

Preparing to install

Crucial parts

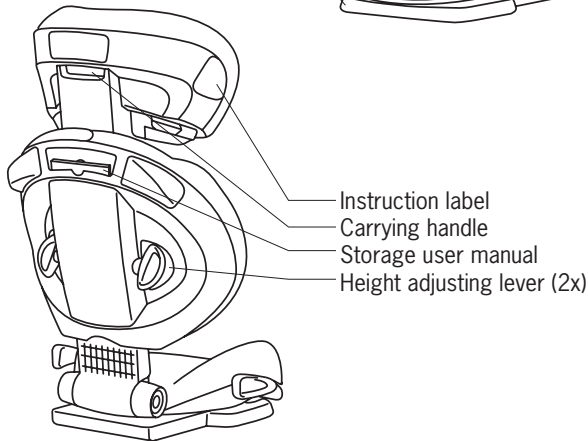
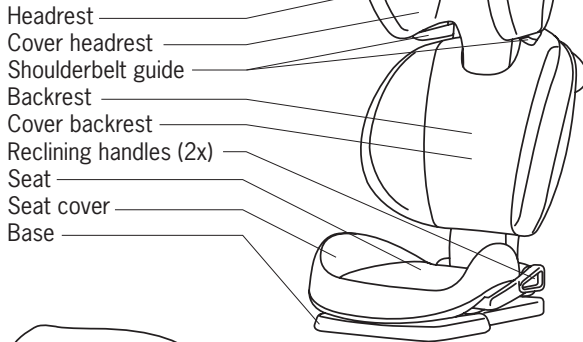

Forward-facing belt installation

- It is **NOT ALLOWED** to mount the seat in a front passenger seat **WITH AN ACTIVATED AIRBAG**.
- When installing the seat in the front car seat: make sure the backrest of the car seat has an upright position. Slide the car seat rearwards as far as possible.



- 1- Place iZi Up on the car seat.
- 2- Make sure the back of the seat is touching the backrest of the vehicle seat. If the head rest of the vehicle is pushing the seat away from the backrest, adjust or remove the headrest (1).

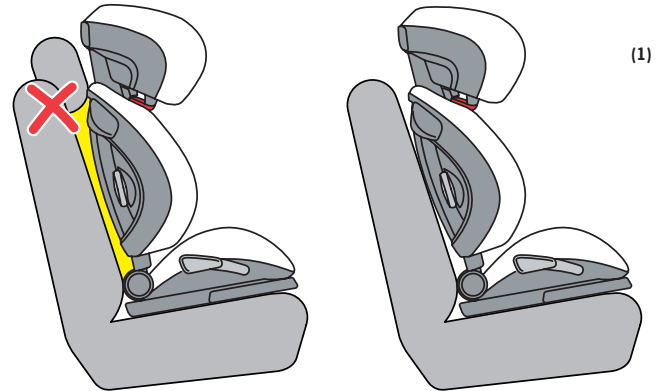

- If the seat feels unstable, even after removal of the headrest of the car, you can use the extra stability strap.
- The stability strap is not an essential safety part and needs only to be used in cars when the iZi Up is connected with the 3-point car belt and when the head rest of the car can not be removed.

Placing the stability strap

- In order to install the stability strap, put the iZi Up and the headrest of the car in the most upward position.
- Guide the stability strap between the cover and the surface of the iZi Up head rest.
- Then guide the strap around both bars of the head rest of the car.
- Adjust the iZi Up to the correct height by turning the height adjusting lever.
- Tighten the stability strap by connecting the velcro strap as tight as possible (2).



- 3- Slide the lower part of the shoulder belt guide open and position the belt in the guide. Make sure the belt is not twisted and close the guide again (3).



- 4- Always close the car three point belt into the buckle before driving, also when the seat is not in use by a child! (4)

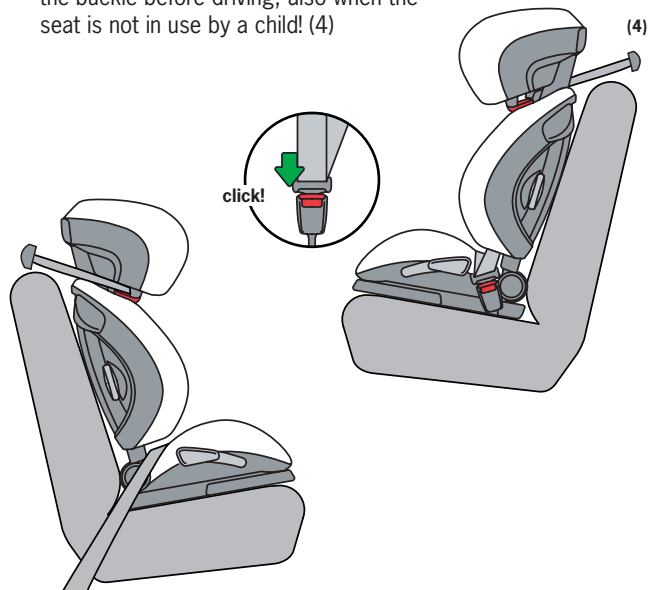

Removing the seat

- 1- Slide the lower part of the shoulder belt guide open and remove the belt from the guide (5).

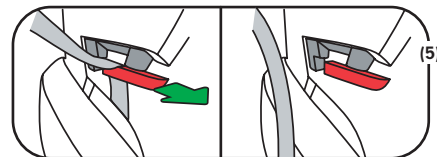

- 2- Take iZi Up out of the car.

Positioning the child

- 1- Adjust the backrest and the headrest to the right height by turning the height adjuster lever. Make sure that the shoulder belt is level with your child's shoulder (6).

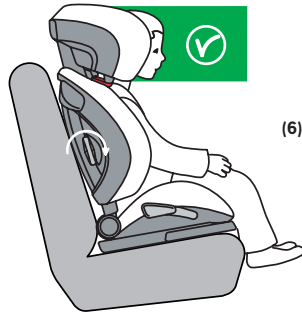

- 2- Slide the lower part of the shoulder belt guide open and position the belt in the guide. Make sure the belt is not twisted and close the guide again (7).



- 3- Lock the belt in the buckle, click. The lap belt should be positioned over the hips (8).

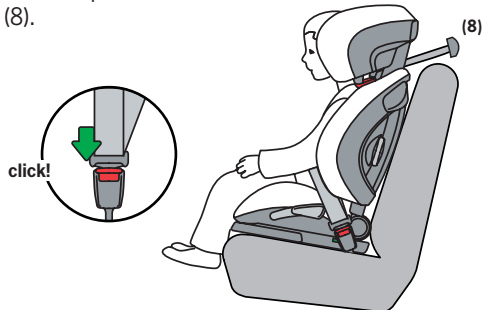

- 4- Remove slack in the belt by pulling the belt towards the retractor (9).

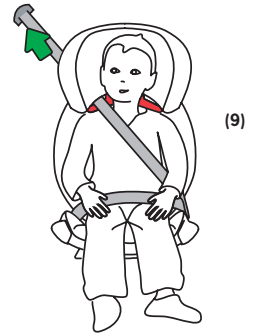

Sleeping position

- The iZi Up can be placed in two sleeping positions by moving the reclining handle upwards (10).

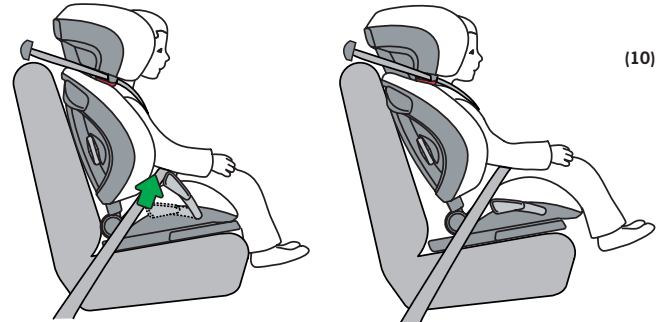

- Push the seat in the direction of the green arrow to return to the upright position. Remove slack in the belt by pulling the belt towards the retractor (11).

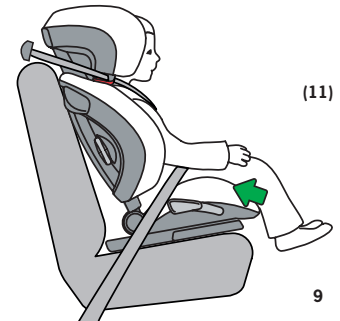

Removing and refitting the cover

Removing the cover

- Pay attention when you remove the cover, as fitting the cover is done in the opposite way.
 - The upholstery of the seat consists of 3 separate parts.
- 1- Remove the back rest cover from the seat by open the velcro at the back, detach the elastic loops from the fixing hooks and pull the cover carefully from the surrounding rim of the back rest.
 - 2- Remove the head rest cover by detaching the elastic loop from the fixing hooks and pulling the cover carefully from the surrounding rim of the head rest.
 - 3- Remove the seat cover by detaching the elastic loops from the fixing hooks and pulling the cover carefully from the surrounding rim of the seat.

Refit the cover

- Refit the cover, using the previous instructions in reversed order.

Cleaning instructions

- The cover of the seat must be washed according to the instructions on the inside of the cover (12).

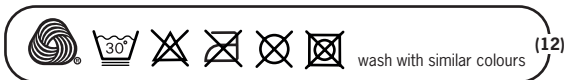

- DO NOT use any aggressive cleaning agents; these may harm the construction material of the seat.

Warning: potential misuse

- It is NOT ALLOWED to mount the seat in a front passenger seat WITH AN ACTIVATED AIRBAG.
- DO NOT guide the car belt around the reclining handles.
- DO NOT use the seat without the 3-point belt (13).



(13)

Point of sale information

Notice for FORWARD-FACING installation

- This is a universal Child Restraint System. It is approved according to regulation No. 44.04, series of amendments for general use in vehicles fitted with 3-point car belts, approved to UN/ECE Regulation No. 16 or other equivalent standards.

Important advice

!

- DO NOT attempt to dismantle, modify or add any part to the seat. Warranty will expire if non-original parts or accessories are used.
- DO NOT use anything, such as a cushion, to raise the child seat off the passenger seat of the vehicle. In an accident the seat will not be able to protect your child in the right way.
- Never leave your child unattended in the seat.
- Make sure all passengers are informed about how to release your child in case of emergency.
- An unoccupied child seat should always be fastened in the vehicle.
- Make sure luggage or other objects are properly secured. Unsecured luggage may cause severe injuries to children and adults in case of accidents.
- Never use the seat without the cover. The cover is a safety feature and may only be replaced by an original BeSafe cover.
- Under the cover we use EPS foam. Do not push or pull too hard against the foam, as you might damage the foam.
- Do not use any aggressive cleaning products; these may harm the construction material of the seat.
- BeSafe advises that child seats should not be bought or sold second-hand.
- KEEP this user manual for later use with the seat.
- DO NOT use at home on a table or worktop, as long as your child is seated in the seat.

Practical advice

When the child seat is mounted in the car check all the areas where the child seat might touch the interior. We recommend using a (BeSafe) protection cover in these places to avoid cuts, marks or discolouration on the interior of the vehicle, especially in vehicles with leather or wooden interior.

Guarantee

- All BeSafe products are carefully designed, manufactured and tested. All of our BeSafe child seats are tested periodically out of our continuous production in our test laboratory. Furthermore they are tested by independent test institutes.
- Should this product prove faulty within 24 months of purchase due to materials or manufacturing fault, except covers and harness straps, please return it to the original place of purchase.
- The guarantee is only valid when you use your seat appropriately and with care. Please contact your dealer, he will decide if the seat will be returned to the manufacturer for repair. Replacement or return cannot be claimed. The guarantee does not get extended through repair.
- The guarantee expires: when there is no receipt, when defects are caused by wrong and improper use, when defects are caused by abuse, misuse or negligence.

2016.03.24
N2002180



HTS BeSafe as
N-3535 Krøderen, Norway - www.besafe.com

BeSafe[®]